

ADVANTECH

Enabling an Intelligent Planet

Green Energy Technology Trends & Solutions Guide

- Renewable Energy
- Battery Energy Storage System
- EV Battery Factory
- EV Charging Station
- Smart Substation

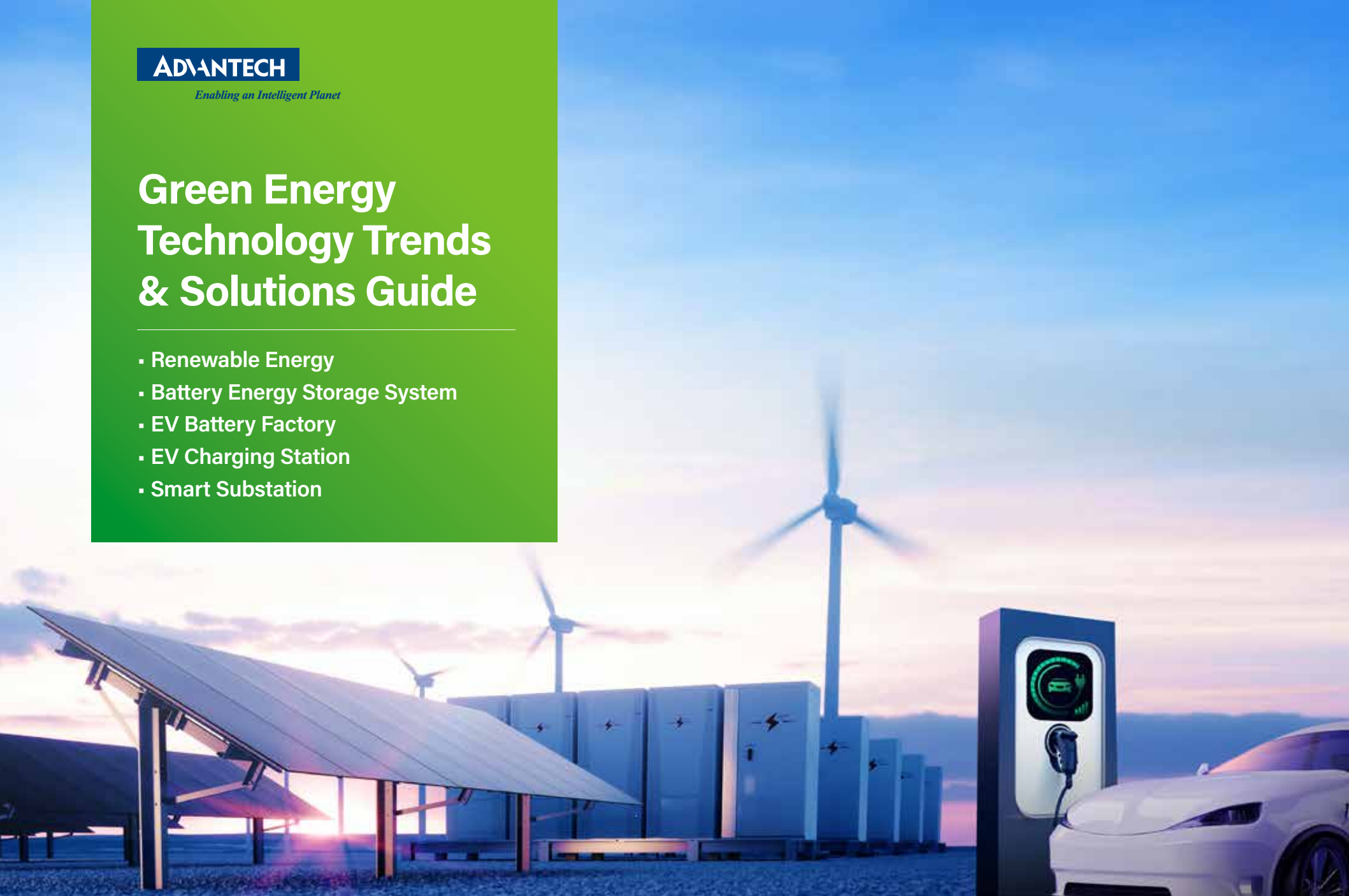



Est. **1983**

Headquarters: **Taipei, Taiwan**

INDUSTRIES SERVED

Industry 4.0, Industrial IoT, Embedded Computing, Medical, Retail, Logistics



\$8.83B MARKET CAP
(Jan., 2023)

HONORS & AWARDS

- No.5 in Best Taiwan Global Brands
- No.17 in Top 50 Global Automation Vendors
- No.9 in Top 100 Industrial IoT Companies
- Red Dot Product Design Award
- iF Product Design Award



WORLD'S LARGEST IPC COMPANY

Advantech IPC WW Market Share

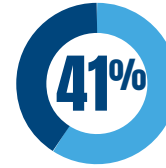

- Advantech
- Other IPC Companies

Source: OMDIA – Market Share estimates for Industrial PCs: World, 2022 Edition

\$2.31B 2022 REVENUE

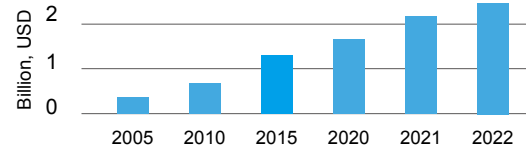

KEY ECO-SYSTEM PARTNERS



QUALITY SYSTEMS IN PLACE

- ISO9001
- ISO14001
- ISO13485
- ISO17025
- ISO27001
- ISO45001
- TL9000
- RoHS
- WEEE
- SONY GP
- REACH

1.8 MILLION+ sq. ft.

MANUFACTURING PLANTS

Linkou, Taiwan



- 8 SMT lines
- Engineering sample services
- Complex product lines
- Flexible & quick production

Kunshan, China



- 11 SMT lines
- Chassis design & production
- Mature product lines
- Cost-effective production



Nogata, Japan

- 4 SMT lines
- Japan design center, CTOS service, logistics center, repair center

WORLDWIDE OFFICES



- Manufacturing 3
- On-site service 4
- Design centers 11
- CTOS centers 16
- Repair centers 17
- Logistics centers 20

More than 90 offices globally!

8800+ EMPLOYEES



Table of Content

Pathways to Future Trends & Opportunities in Green Energy

3

Renewable Energy (Solar/Wind)

5

- Embracing Digitalization: The Future of Renewable Energy Management
- Renewable Energy Generation Business Eco-System
- Solar Photovoltaics (PV) Monitoring Application Diagram
- Case Study | Cost-Effective, Scalable, Smart Energy Management Systems

Battery Energy Storage System (BESS)

9

- Mastering Energy Storage in the Renewable Energy Era
- Battery Energy Storage System Eco-system
- All-in-One BESS Application Diagram
- Grid-Scale BESS Application Diagram
- Behind-the-Meter BESS Application Diagram
- Case Study | Building a Connected IoT Infrastructure to Achieve BESS efficiency

EV Battery Factory

15

- Innovating EV Battery Production through Advanced Automation and AI
- EV Battery Manufacturing Business Eco-system
- Smart Maintenance & Quality Control in EV Battery Manufacturing
- Case Study | Improving Quality Assurance with Advanced AOI Solution in EV Battery Production Line

EV Charging Station

19

- The Expansion of EV Charging Stations and Emerging Business Models
- EV Charging Station Business Eco-System
- EV Charging Station Application Diagram
- Case Study | Data Collection and Transmission System for Electric Vehicle Charging Points

Smart Substation

23

- The Digital Grid and Substation Virtualization
- Power Grid Business Eco-System
- IEC 61850 Substation Platform Application Diagram
- Application Story | Smart Substations: Centralized Digital Control for Enhanced Resilience

Product Offering Highlight

27

Pathways to Future Trends & Opportunities in Green Energy

With global trends in green energy, ESG initiatives, and relevant regulations, global renewable energy capacity is expected to reach 4800GW by 2026. According to a Gartner report, this will require businesses to invest heavily in on-site renewable energy generation and storage in order to optimize their long-term energy costs, while contributing to energy security on a larger scale. This is leading energy retailers and energy management companies to investigate and implement behind-the-meter renewable energy generation as well as alternate forms of energy or power augmentation services.

Growing markets in green energy include energy services for on-site generation, energy storage, EV chargers, planning and financing of microgrids, and digital substations. These projects will all require installation, operation, and maintenance. Demand for hybrid energy storage systems in particular is expected to grow with increasing penetration of distributed renewable energy generation, and this will require the development of intelligent energy storage technologies that will make batteries more durable and safer to operate.

Technologies driving this evolution in energy storage include AI, digital twinning, and self-healing materials. Given the massive deployment of IoT sensors that is required to successfully ensure the safe and efficient operation and management of such systems, it is critical that suitable energy storage solutions be developed for the environments in which they operate.

Relevant regulations have already been proposed to help build a circular economy for batteries, such as the 2026 target for European battery passports, which will largely depend on the collection of information pertaining to battery performance and durability. They will also serve as the equivalent of a health record for batteries. Collectively, the shift away from centralized utility-delivered power is both aimed at, and driven by the digitalization, decarbonization, decentralization, and democratization of energy.



Digitalization

Energy digitalization means establishing energy storage solutions that can facilitate the integration of renewable energy into smart, flexible power systems. The effects of digitalization will impact the entire process, from generation and storage, to distribution and consumption. If businesses wish to take control of their energy needs, they will need to deploy real-time AI capable energy systems.

Decarbonization

Advancements in decarbonization will require businesses to re-evaluate their objectives by exploring viable decarbonization pathways and alternative financing options in order to reduce emissions. A key consideration will be for businesses to partner with suppliers who can aid them in achieving energy efficiency targets through the deployment, operation, and management of renewable energy systems.

Decentralization

Decentralization is becoming critical to achieving energy security. It will require significant contribution from businesses, especially larger enterprises, in the adoption of self-generation solutions that will allow them to manage their own energy needs through the construction of micro grids.

Democratization

Energy democratization will continue to involve public effort in the transition toward renewable energy. By enabling independent energy producers and energy trading, the entire sector can be better guided, and be more responsive, by policies and decisions that are made on the basis of localized needs.

Reference

Sarah Watt, Lauren Wheatley, Atrishi Badu (4 October 2022), Executive Leader Strategies to Balance Energy Cost, Security and Decarbonization, Gartner Report



Renewable Energy (Solar/Wind)

As the world's energy landscape shifts, renewable energy sources like solar and wind are becoming increasingly important. Rapid growth in this sector is driving demand for innovative management solutions that optimize energy integration and foster a sustainable future.

According to the International Energy Agency (IEA), renewable capacity will meet 35% of global power generation by 2025.

Embracing Digitalization: The Future of Renewable Energy Management

Addressing the challenges faced by renewable energy generators is crucial to meeting their targets. Traditional IT/OT systems are inadequate for managing the complex and dynamic operations required to scale up renewable energy generation across a diverse energy ecosystem. Thus, emerging technologies that can handle real-time environmental conditions and facilitate more efficient management are critical.

Such technologies build upon existing tools that support remote energy operations. Vendors are now developing modular products with individual APIs that simplify integration into third-party environments. To optimize renewable energy generation and management, a comprehensive toolbox is required, including:

- *Big data and predictive analytics: Providing real-time insights for informed decision-making.*
- *Cloud computing: Enabling connectivity and data exchange across various platforms.*
- *Modular architecture: Supporting diverse business models and integration with existing systems.*
- *Intelligent solutions: Collecting data on equipment performance to ensure optimal operation.*

As digitalization revolutionizes the renewable energy sector, these technologies will be vital to managing the growing complexity of energy generation and distribution. Hence, these innovations will help renewable energy providers improve efficiency, reduce costs, and contribute to a more sustainable future.

[Learn More](#)

Renewable Energy Generation Business Eco-System

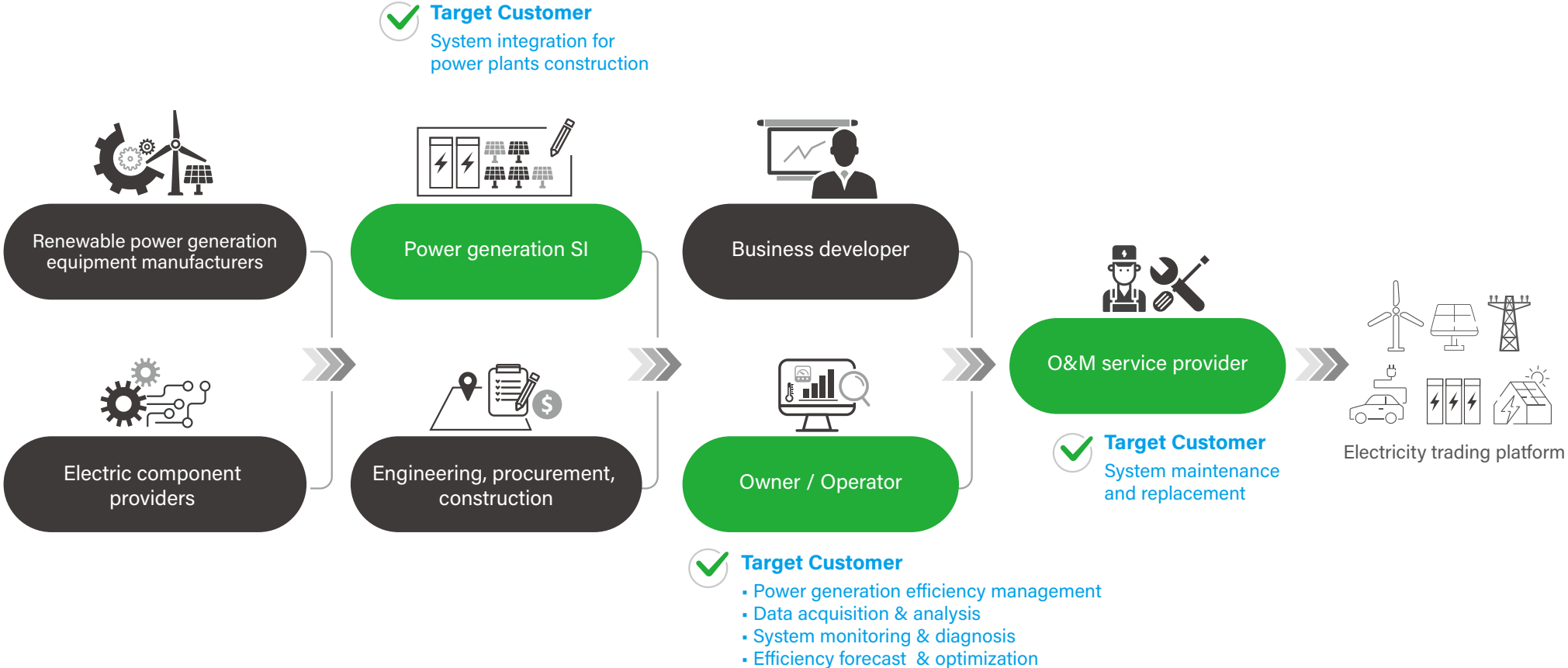

Solar Photovoltaics (PV) Monitoring Application Diagram

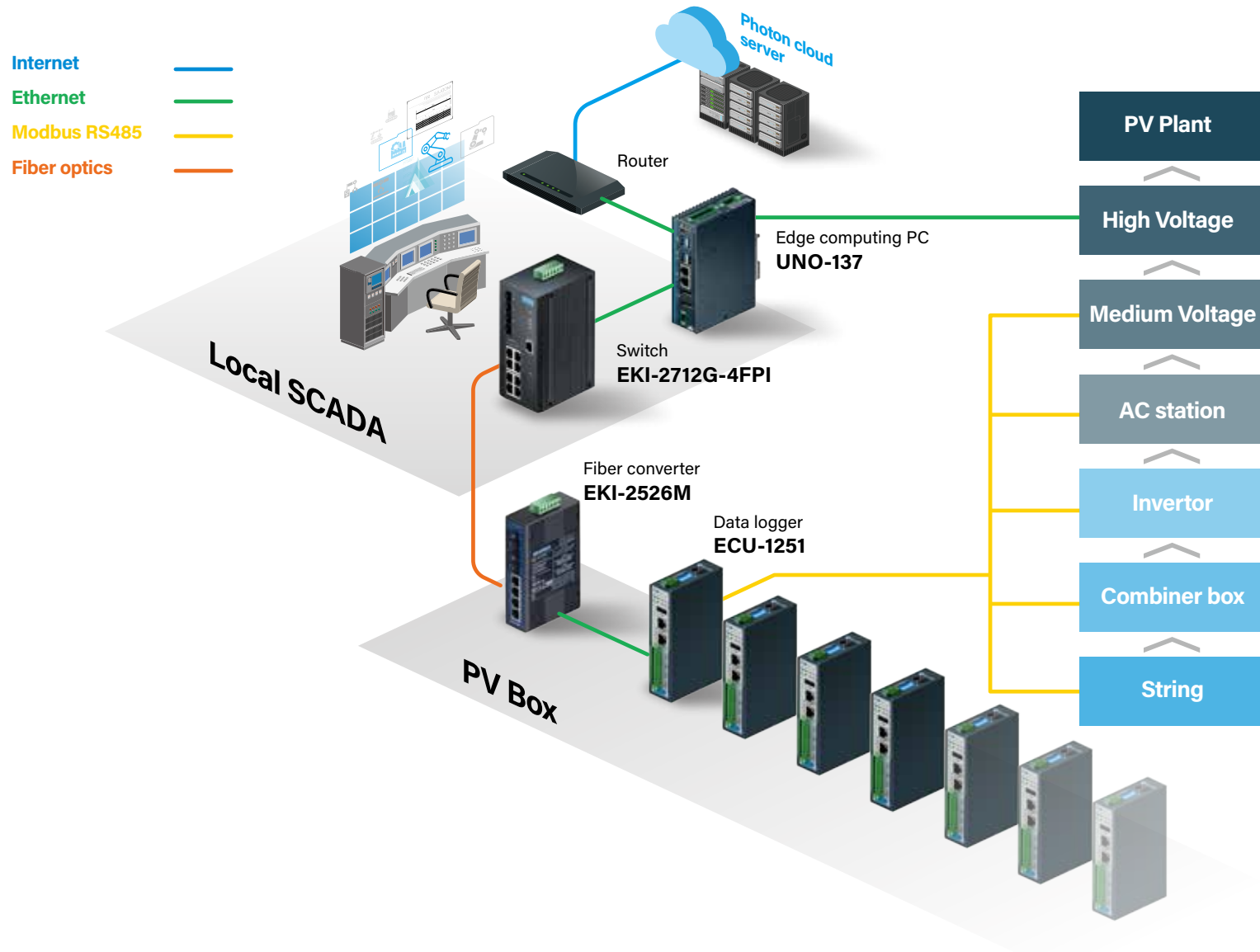

Case Study | Cost-Effective, Scalable, Smart Energy Management Systems

A reliable Solar Monitoring platform with data collection and transmission to cloud-based monitoring systems, including meteorological sensors, inverters, energy meters, and LV transformers.

Challenges / Requirements:

- Implement green technology for potential project bids to tap into the rising demand for greener and more sustainable buildings.
- Improve sustainability through better energy, environment monitoring, and management.
- Carry out the supply, installation, commissioning, and integration of two 1.5 megawatt-peak (MWp) floating solar PV systems.

Solution:

BBR designed a solution to extract data from meteorological sensors, inverters, and DC combiners and convert it to Transmission Control Protocol (TCP) to safeguard the reliable process of packets. The system uses an energy gateway device to collect Modbus/TCP data from the field. The data is locally stored, then obtained using Advantech's data logger (IPC ESRP-UNO-2484).

Benefits:

- Allows key energy management tasks and maximizing solar power output.
- The use of a web-based platform makes immediate access to data possible.
- Produces enough green energy to supply 30% of the total energy requirements for the installation.



MiRai

Location:
Singapore

Company:
Mirai Electronics Pte Ltd -

"Full range of products include cost competitive H/W and S/W platforms that support scalable projects!"

Keith Chong, Project Director, BBR Greentech

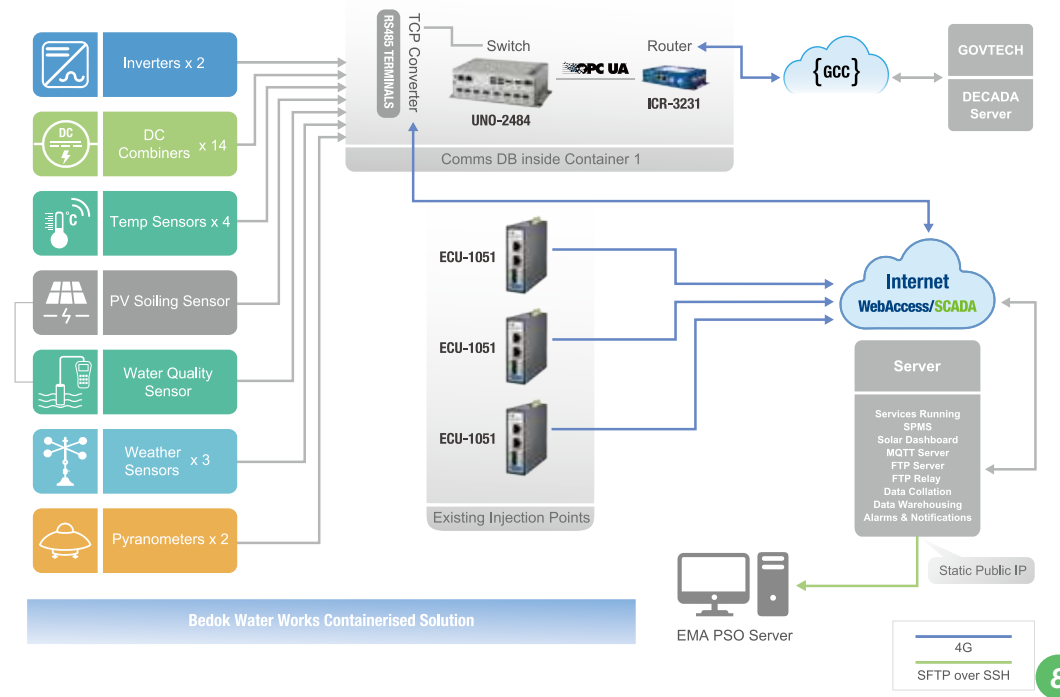

Battery Energy Storage System (BESS)

The world's shift toward renewable energy and decarbonization has made energy storage more crucial than ever before. Ensuring power is delivered reliably, where and when it's needed, is an unprecedented challenge in the renewable energy landscape. Current energy storage systems employ a range of technologies to balance electrical supply and demand, fostering a flexible and sustainable energy infrastructure.

The International Energy Agency predicts that global installed storage capacity will grow by 56% in the next five years, reaching over 270 GW by 2026.

Mastering Energy Storage in the Renewable Energy Era

This rapidly evolving context presents several trends and opportunities, including the growth of distributed renewable energy driven by government promotion of renewables and rising demand for microgrids. Decarbonization initiatives are leading to substantial demand for battery storage systems. Additionally, the digitalization of grids for real-time demand management will involve leveraging IoT technologies such as smart meters, sensors, remote operations and maintenance (O&M), and AI.

However, there are also notable challenges. Aligning renewable energy generation with fluctuating demand and managing the variability of renewable energy sources can be difficult. Addressing the high peak power demand of faster EV charging and superchargers, which is challenging to forecast, is another issue. Ensuring the availability of reliable device vendors and global services to support energy storage is also essential.

Advantech is well-positioned to address these challenges with our comprehensive product portfolios for battery energy storage system (BESS) builders, system integrators, and O&M service providers. Our global logistics, technical support, and services can help customers navigate the future of energy generation with efficient BESS solutions.

[Learn More](#)

Battery Energy Storage System Eco-system

BMS : Battery Management System
PCS : Power Conversion System
EMS : Energy Management System
ECS : Environment Control System
ESS : Energy Storage System

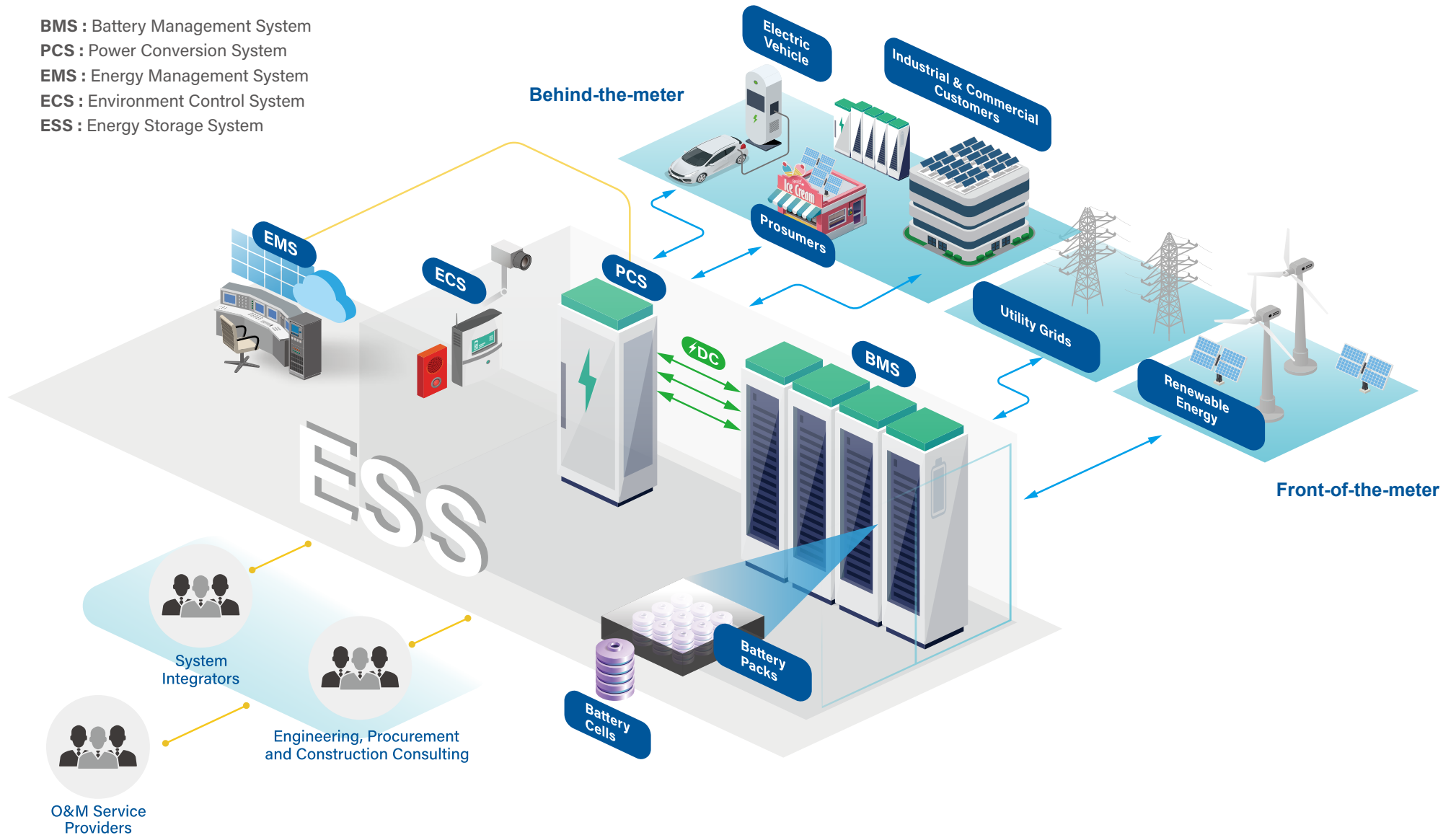

All-in-One BESS Application Diagram

BESS : Battery Energy Storage System

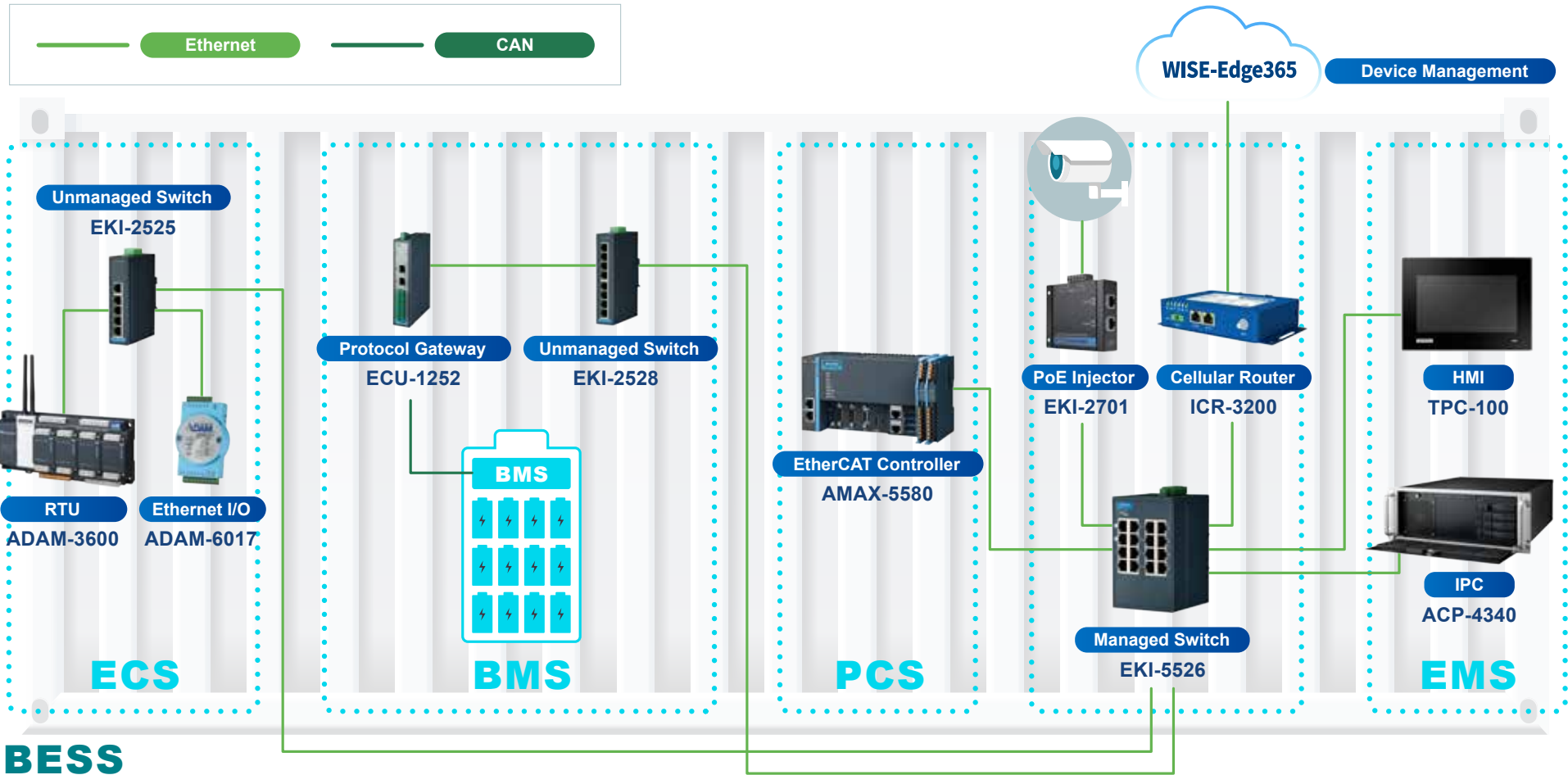

Grid-Scale BESS Application Diagram

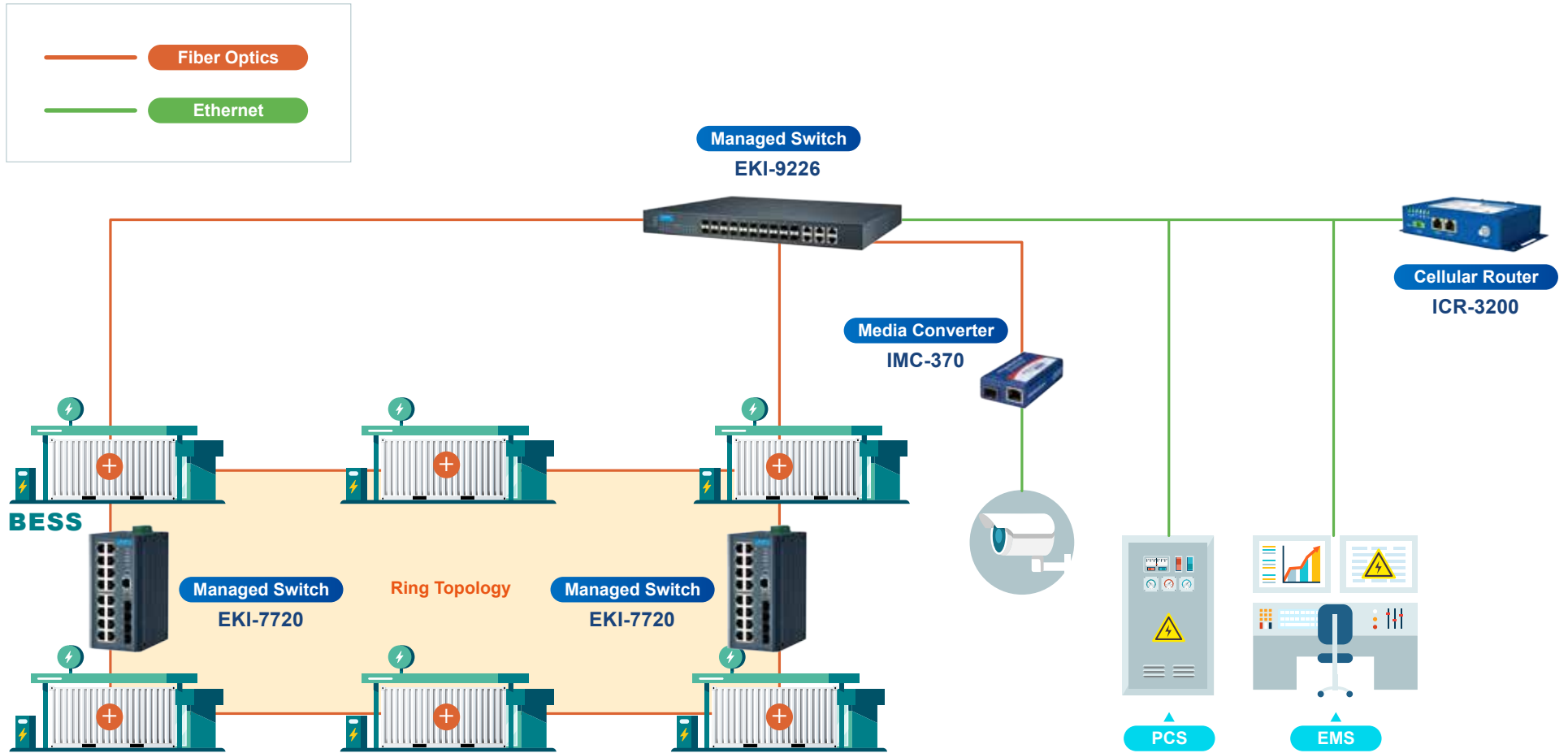

Behind-the-Meter BESS Application Diagram

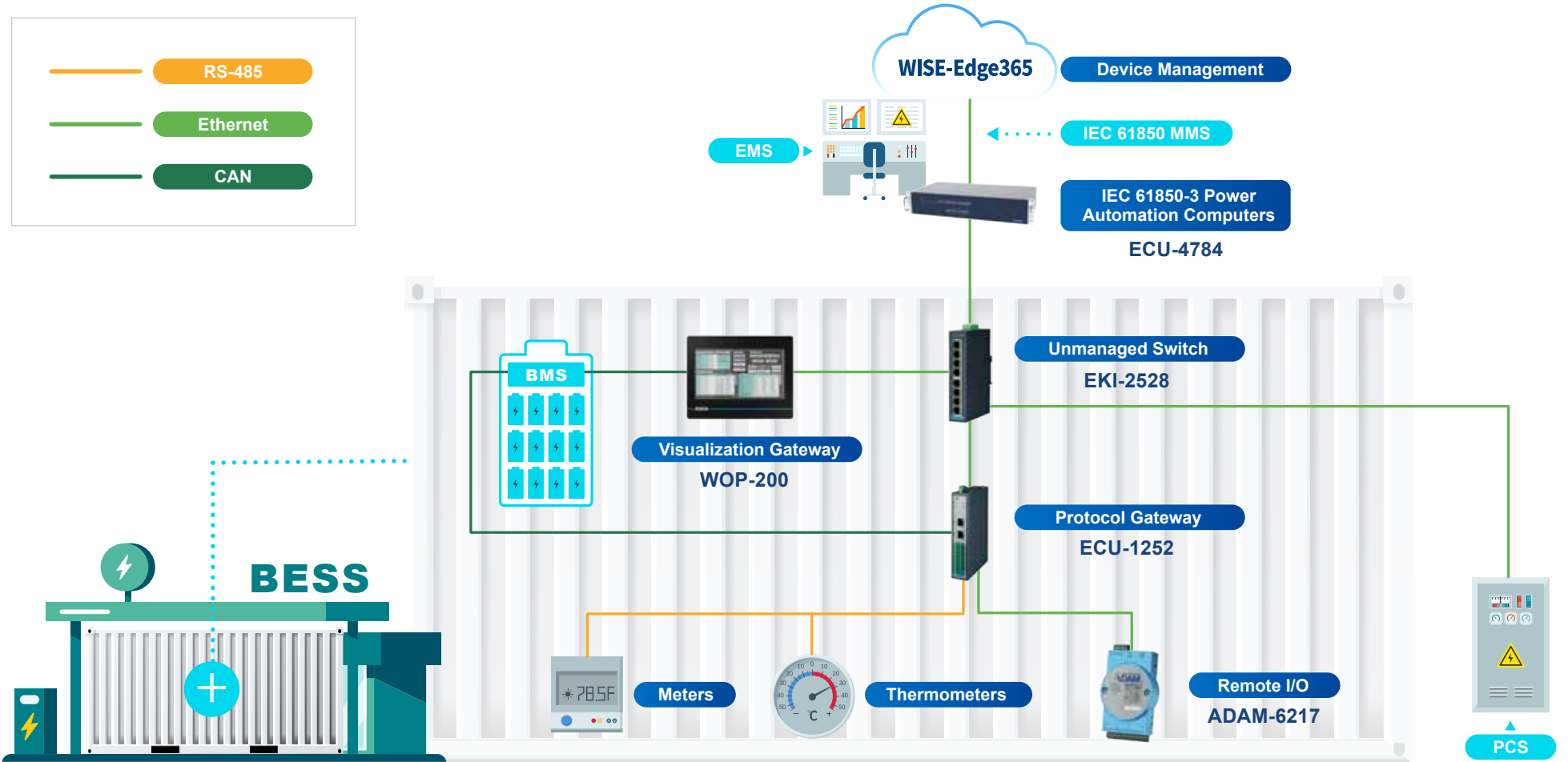



EV Battery Factory

Lithium-ion batteries, essential for electric vehicles (EVs), use active and sensitive materials. This means that imperfections during production can lead to diminished battery performance, capacity, and lifespan, or even accidents. Because battery production operates on an economy-of-scale basis, any interruptions can cause substantial financial losses. State-of-the-art technologies are integrated thus essential to battery manufacturing to guarantee battery quality and equipment availability.

Machine vision systems ensure quality inspection and traceability in production lines. This requires real-time control systems to handle robots and actuators for accurate material management, with smart sensors employed to monitor conditions. AI technology is extensively employed to improve inspection precision and facilitate predictive maintenance.

Innovating EV Battery Production through Advanced Automation and AI

Emerging trends include the extensive application of AI in image analysis and big data analytics, which plays a vital role in machine vision and equipment predictive maintenance. Gigafactories and their equipment suppliers require partners capable of delivering ready-to-use, AI-driven solutions for quality assurance and OEE improvement projects.

Advantech provides cutting-edge edge platforms driven by the latest CPU/GPU computing technologies. Additionally, Advantech actively cultivates robust alliances with co-creation collaborators in AI, real-time control, and intelligent manufacturing. These partnerships are essential for delivering top-of-the-line hardware platforms, devices, and automation resources to battery manufacturers.

According to IEA, in 2021, demand for automotive lithium-ion batteries reached 340 GWh, more than twice the demand in 2020. It is projected that the demand for EV batteries will grow to over 3,500 GWh by 2030. By 2030, battery demand from EVs is expected to increase to between 2.2 and 3.5 TWh, requiring the construction of 52 to 90 additional gigafactories with an annual production capacity of 35 GWh. This growing need for automation technology in gigafactories presents significant opportunities for Industry 4.0 applications.

[Learn More](#)

EV Battery Manufacturing Business Eco-system



Smart Maintenance & Quality Control in EV Battery Manufacturing

— Facility Monitoring Solution
— Manufacturing Equipment
— Test Equipment

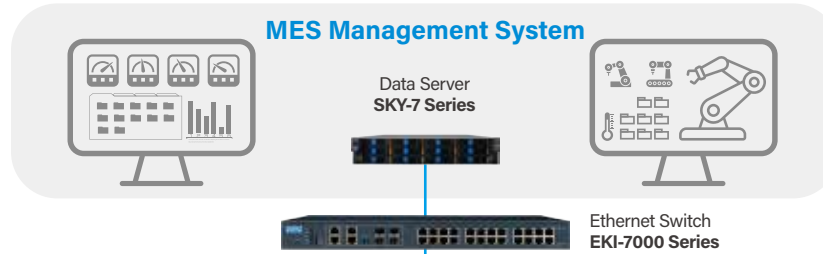

Data Transmission

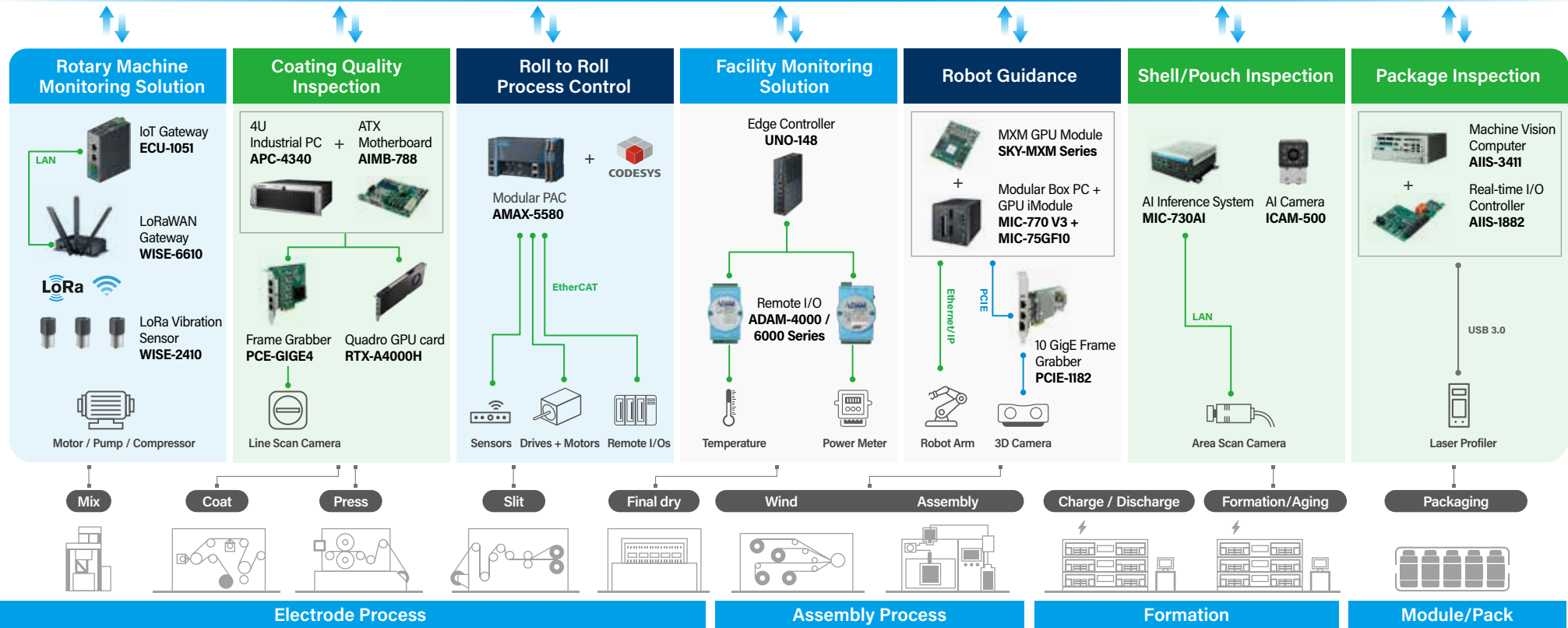

Case Study | Improving Quality Assurance with Advanced AOI Solution in EV Battery Production Line

Battery makers are facing a surging demand from electric vehicles and stationary energy storage systems. This is accelerating the creation of new technologies for manufacturing to boost production performance. Vision inspection is one of those important technologies that can meet these requirements. Advantech works on automation projects for gigafactories, which helps create new IPC design opportunities in a virtuous cycle of development.

Challenges / Requirements:

- Overcoming poor quality-inspection performance.
- Overcoming the difficulty of upgrading and expanding.
- Need for reliable HW with long-term support.
- Material and supply chain shortages.

Solution:

- 4U Industrial PC supports 12th Gen. Core™ i, with shock proof, front accessible drive bays, reinforced cooling solution for harsh environment.
- High-performance GPU card with longevity support for image processing and AI inference – Quadro RTX-A4000H.
- PoE GigE vision frame grabber card with remote camera power on/off function – PCIE-1674.

Benefits:

- CTOS service for flexible configuration to meet different spec requirements of various machines.
- 1Grms vibration, 40°C temp, 10G shock industrial reliability minimizing system down time.
- Remote PoE camera power on/off minimizes maintenance time.
- Global certification service and regional service center support.



Location:
China & Korea

Customer:
EV Battery System Integrator

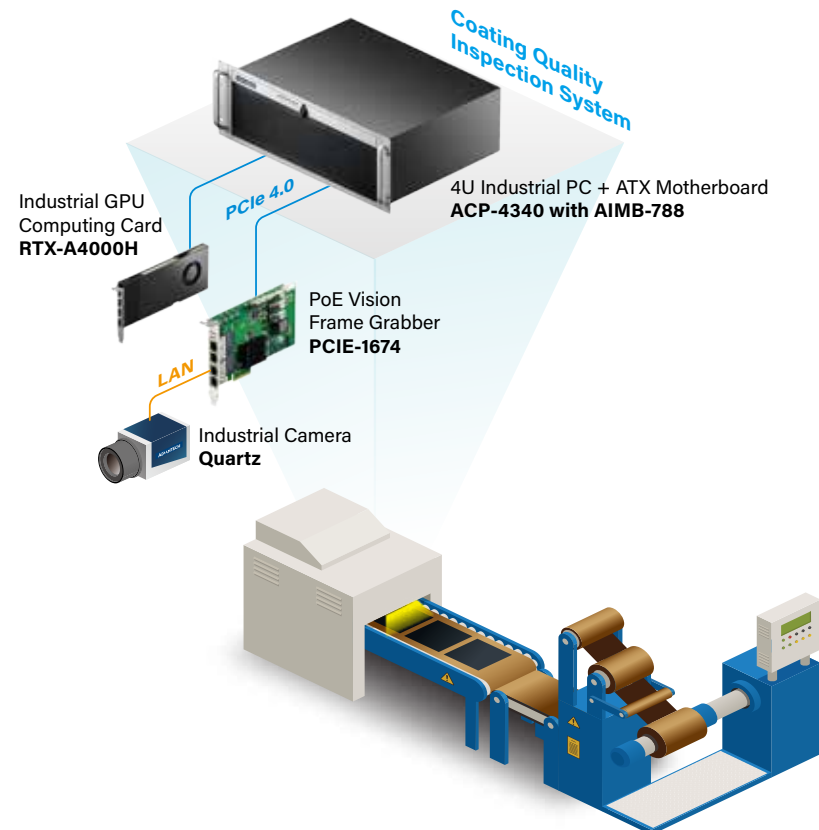

EV Charging Station

Demand for electric vehicles (EVs) is growing due to corporate sustainability strategies, government financial incentives, and stringent environmental laws. Consequently, many enterprises are investing in EV charging solutions and entering the EV charging station market. EV charger manufacturers and engineering procurement and construction companies are increasingly installing EV chargers in various locations, providing a wide range of services such as installation, operation, and maintenance of EV charging stations. This enables enterprises to adopt these solutions without significant capital investment.

While home and workplace charging are likely to fulfill a large portion of the overall demand, the number of public chargers still needs to increase significantly to over 15 million units by 2030.

The Expansion of EV Charging Stations and Emerging Business Models

Various business models have emerged globally, offering a range of EV charging station solutions. These models provide a choice of AC/DC charging technologies suitable for residential or fleet use, and different public or private locations. Key factors for charging station service providers include customization capabilities to meet distinct requirements, network reliability to ensure service quality, and integrated services to enable remote monitoring and predictive maintenance.

To meet the increasing need for electric vehicle (EV) charging solutions, Advantech is actively creating groundbreaking products and solutions. Through customizable offerings, reliable network maintenance, and comprehensive services, Advantech empowers customers to develop inventive business models and charging technologies. This enables them to address a wide array of requirements and contribute to a greener, more efficient future for electric transportation.



EV Charging Station Business Eco-System

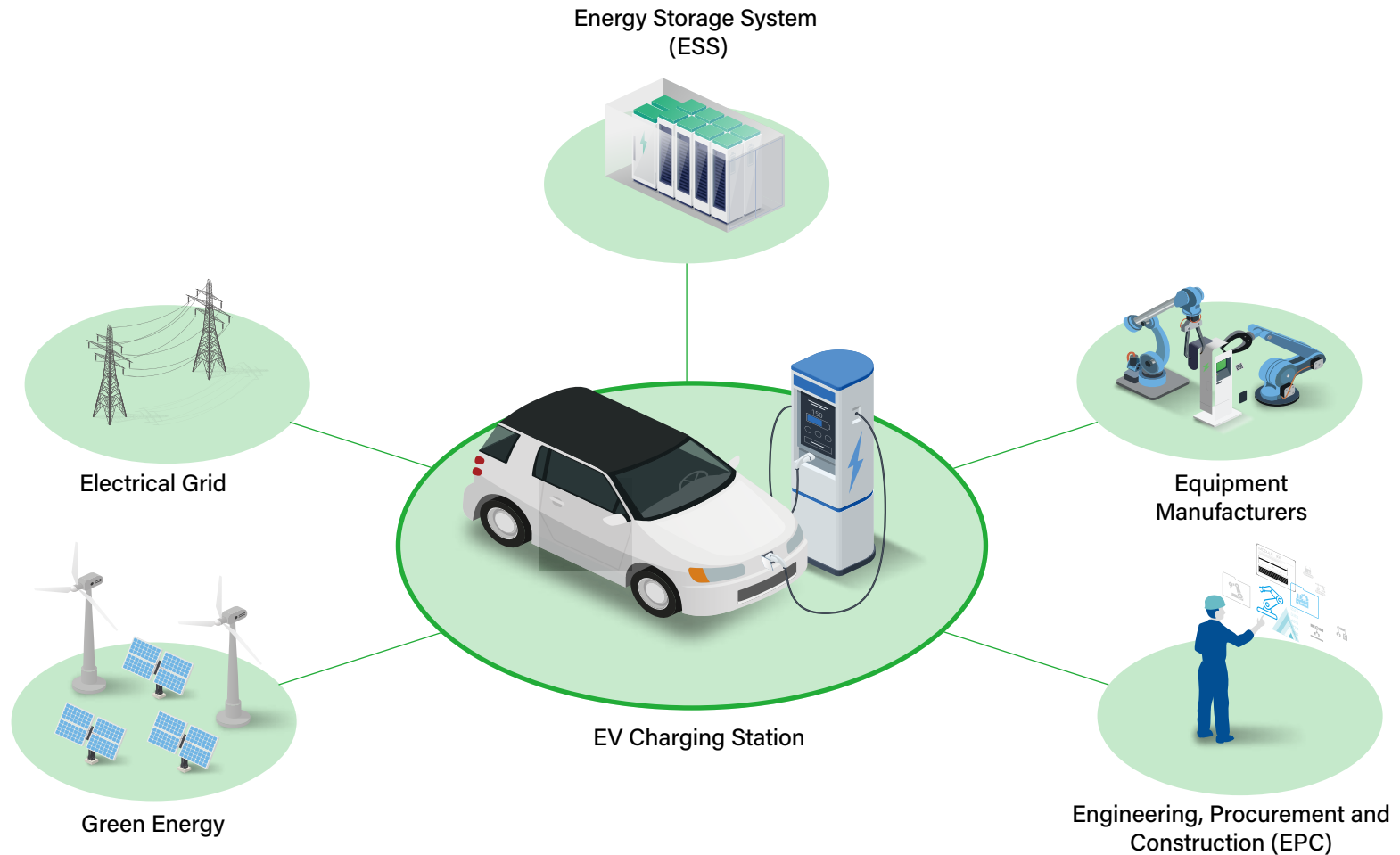

EV Charging Station Application Diagram

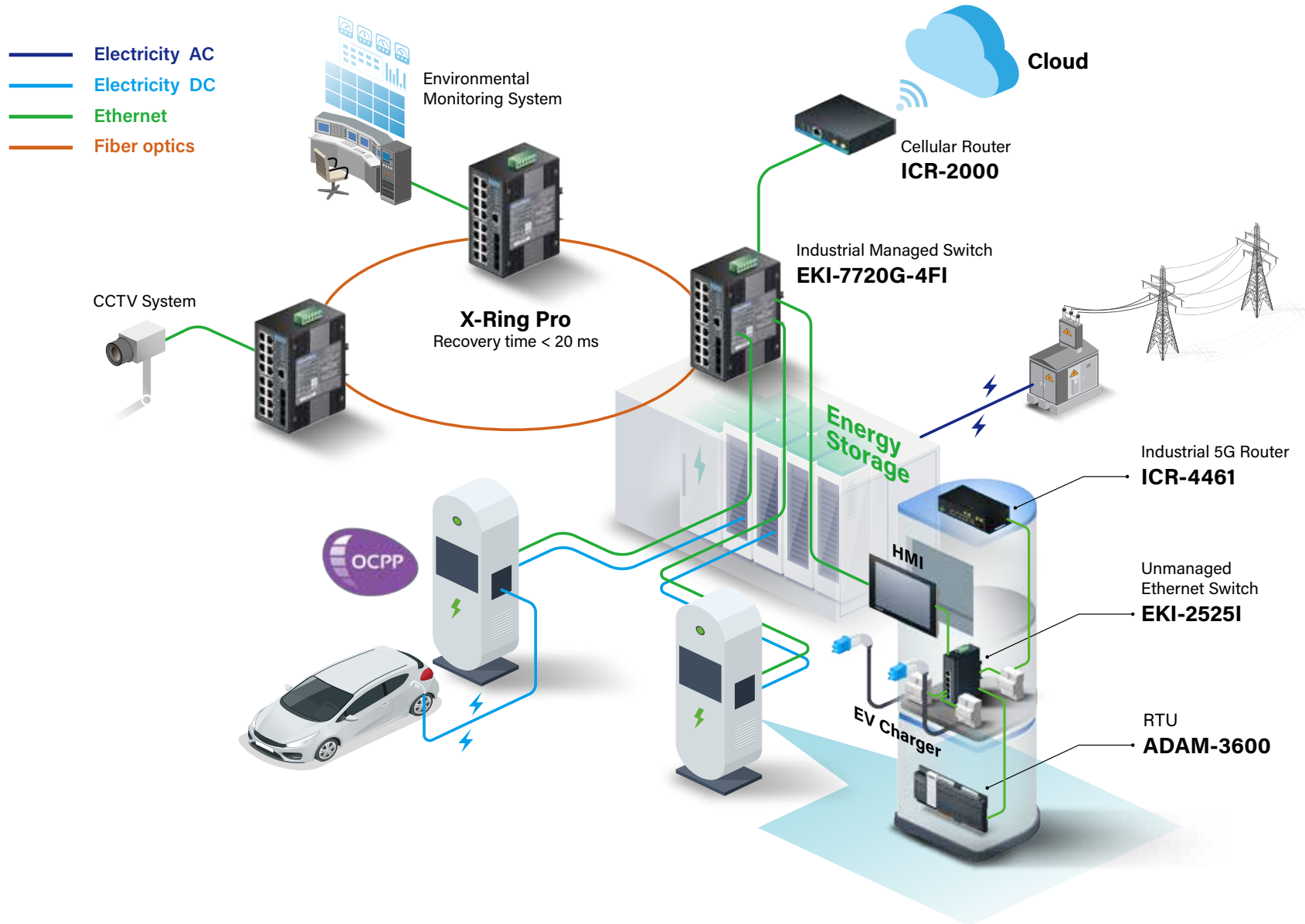

Case Study | Data Collection and Transmission System for Electric Vehicle Charging Points

The charging stations set up by the customer use Advantech solutions for data collection and transmission via charge point protocol (OCPP), which means all data will reliably reach the backend system.

Challenges / Requirements:

- Most large-scale commercial pay-per-use DC charging stations are located outdoors, therefore the charging points must be able to withstand environmental and weather conditions such as dust, precipitation, sustained periods of sunshine, and extreme temperatures.
- Charging stations must be able to transmit data reliably. Information such as charging volume and billing details must be transmitted through OCPP, and functions such as backend system management, remote real-time station monitoring, and energy management must also be integrated.

Solution:

Payment information entered in charging stations by the user is sent to the remote data center via the Advantech ICR-4461 5G cellular router. After the payment is made, data is then transmitted to the charging point controller through the Advantech EKI-2525I industrial unmanaged switch, which sends a signal to turn on the current in the charging station and send power to the connected EV.

Benefits

- Real-time monitoring system significantly improves management efficiency.
- Provides an easy, convenient, and reliable charging experience for EV users.

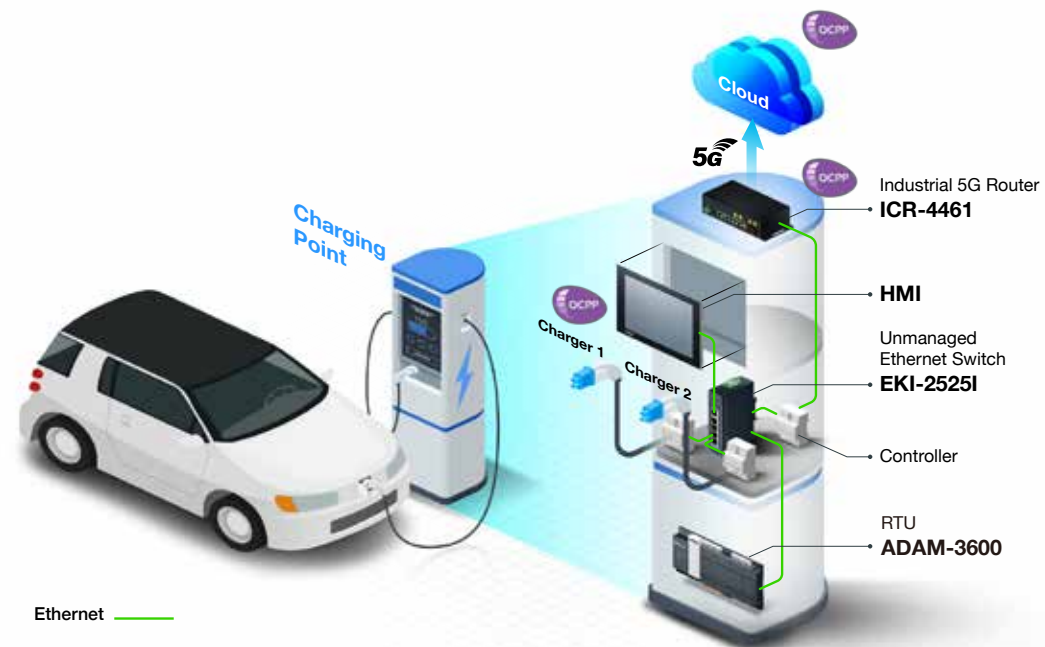

Smart Substation

The digital grid harnesses connectivity to unite energy consumers and producers, facilitating bidirectional energy transmission. In digital grid investments, the digitalization and virtualization of substations have emerged as crucial elements. These advancements are made possible by the progress in edge computing, edge AI, IT/OT integration, advanced distribution protection, and software-defined assets.

The Digital Grid and Substation Virtualization

Traditional substations rely on copper cables for point-to-point connections, resulting in costly testing and maintenance. Critical assets often lack adequate condition monitoring, leading to information silos and cyclical maintenance strategies. Today's digital substations utilize digital communications, replacing fiber optic networks and copper signal lines. Such secure, high-performance digital infrastructure drives operations and relays asset condition data to cloud-based systems that then leverage predictive algorithms to enhance maintenance effectiveness.

The outcome is reduced maintenance costs, extended asset life, decreased environmental impact, and improved worker safety. This helps utility companies optimize maintenance expenditure, construct substations with smaller footprints, and shorten the time required to build new substations, to deliver reliable, affordable power while generating profit.

The reliability of power system protection, monitoring, control, and asset management has significantly increased from electromechanical relays to modern IEDs. Today's utility information systems utilize standard networking concepts and virtualization, housing multiple systems on a single platform. This reduces the number and variety of devices in substations, saving money and resources while simplifying maintenance. Key to this is virtualization, which is an essential tool for making the grid more sustainable and resilient, thus contributing to the global transition to clean power.

[Learn More](#)

Power Grid Business Eco-System

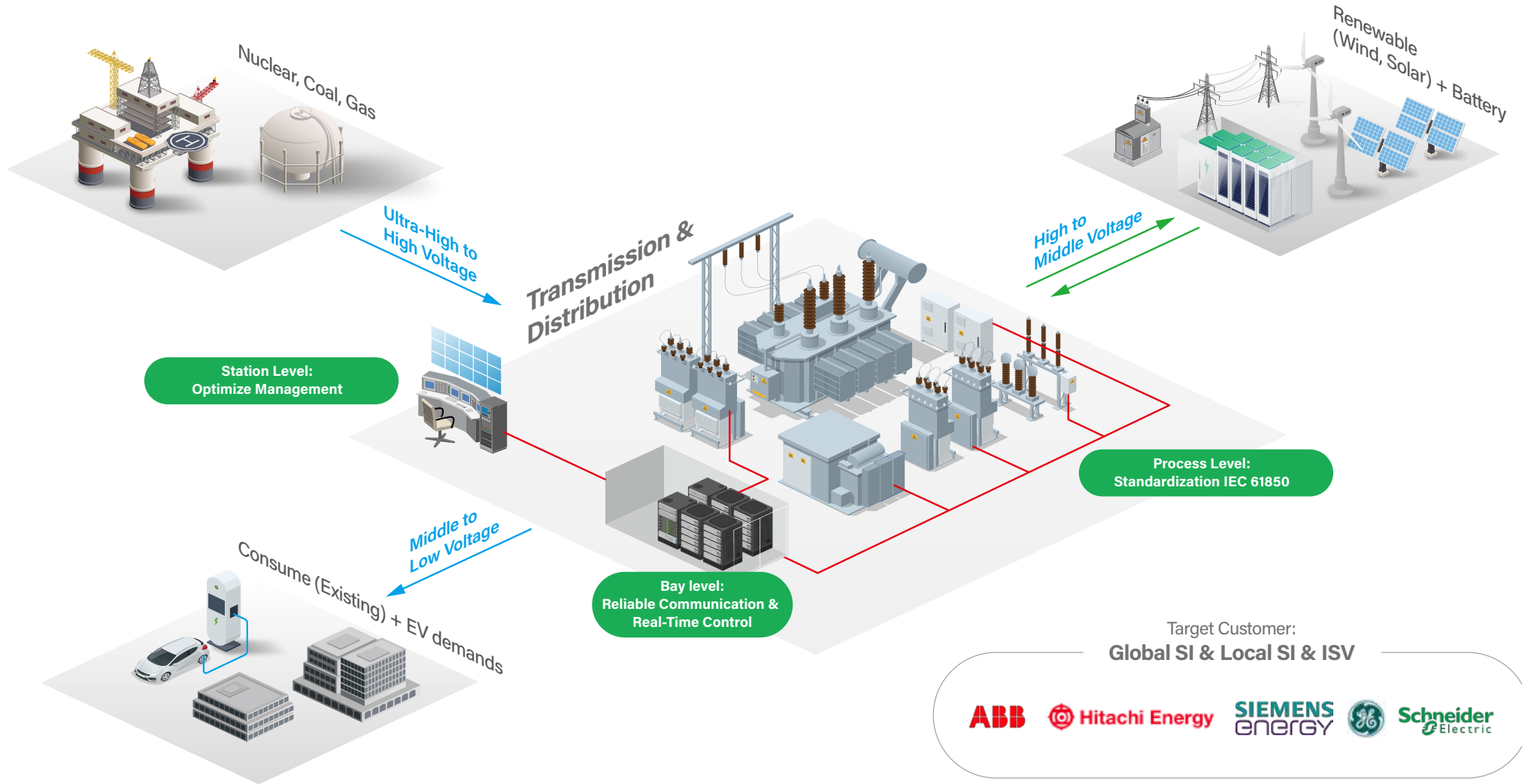

IEC 61850 Substation Platform Application Diagram

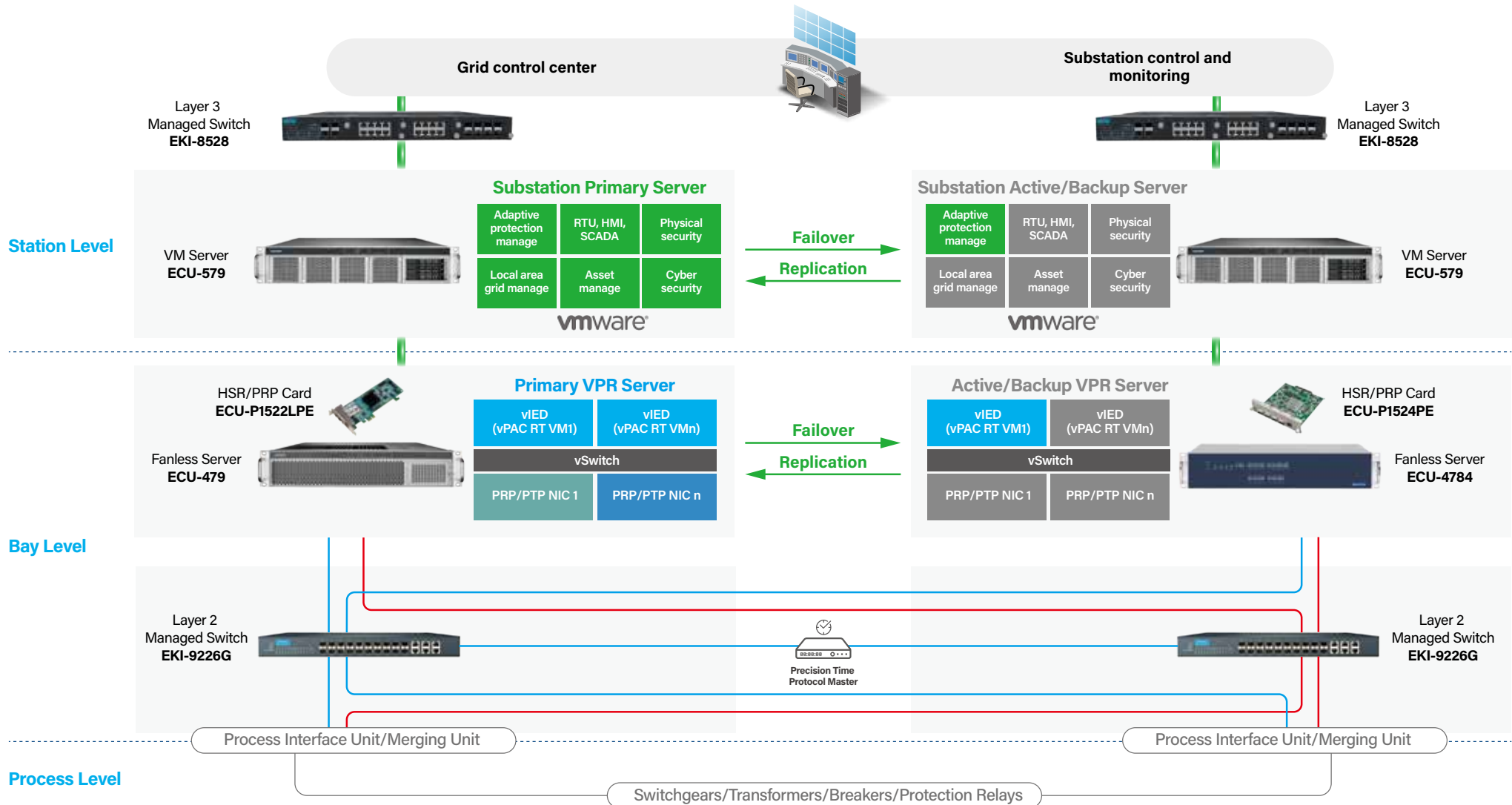

- STD Ethernet** — Green line
- HSR/PRP** — Blue line
- HSR/PRP** — Red line
- HSR** – High Availability Seamless Redundancy
- PRP** – Parallel Redundancy Protocol
- VPR** – Virtual Protection Relay

Application Story | Smart Substations: Centralized Digital Control for Enhanced Resilience

Centralized digital substation control simplifies operations by consolidating functions into a single device. Advantech ECU-579, in collaboration with software partners and combined with legacy units, offers a customizable solution for digitalizing substations. This case study explores the benefits and features of the system.

Challenges / Requirements:

- **Centralization:** The need to centralize protection and control functions into a single device.
- **Versatility:** Ability to handle a wide range of utility and industrial applications, reducing engineering efforts.
- **Cost-effectiveness:** Achieving station-wide visibility and streamlined process management at minimal costs.

Solution:

Advantech ECU-579 serves as the core of the system, complying with the IEC 61850-3 standard and providing unparalleled flexibility throughout the substation's lifecycle. To enhance its capabilities, our customer developed modular software, enabling the virtualization of the digital substation control and protection device. This empowers a single device to handle multiple protection relays, simplifying the network and supporting optimal asset management.

Benefits:

- **Cost Savings:** Reduced device and maintenance costs through centralized protection and control.
- **Network Simplicity:** Minimized complexity by consolidating protection and control functions.
- **Efficient Process Management:** Streamlined process management with comprehensive station-wide visibility.
- **Flexibility and Scalability:** Fast, easy, and cost-effective substation system upgrades to meet evolving network protection requirements.
- **Support for Digitalization:** Designed to support the increasing digitalization of substations.



Shunt capacitor



Base Functionality



Interconnection



Transformer



Busbar



Motor



Feeder



Arc flash



ECU-579

Common Substation Platforms

PCIe Cards



ECU-579

IEC 61850-3 Virtualization Server

- 2nd Generation Intel® Xeon® Scalable Processors
- 12 x DDR4 RDIMM/LRDIMM with ECC, support up to 768GB
- 4 x 2.5" hot-swappable HDD/ SSD, 1 x M.2 2280 NVMe/SATA
- 2 x hot-swappable PSU (100-240 V_{DC}/V_{AC})
- 2 x PCIe x16, 1 x PCIe x8, 1 x PCIe x4 Gen. 3 slots, 1 x ECU-P slots
- IPMI 2.0-compliant management

ECU-479

IEC-61850-3 Automation Server

- 13th Generation Intel® Core™ processors
- 2 x DDR4 SODIMM with ECC, support up to 64GB
- 4 x 2.5" swappable SSD, 1 x M.2 2280 NVMe/ SATA
- 2 x swappable PSU (100-240V_{DC}/V_{AC}, 48V_{DC} optional)
- 3 x PCIe x4 Gen. 3, 1 x PCIe x16 Gen. 4, and 1 x ECU-P slots

ECU-4784 Series

IEC-61850-3 Automation PC

- Intel® Xeon® E-2276ML, up to 64G DDR4 ECC RAM
- Intel® Xeon® E3-1505L v5, up to 32G DDR4 ECC RAM
- Intel® 6th Core™ Celeron, i3, i5, i7 Processor up to 16G DDR3L RAM
- 8 x Giga LAN, 2 x RS-232, 8 x RS-232/ 422/ 485 serial ports
- 3 x Display output/ 3 x SATA/ 2 x I/O expansion slots

ECU-P1522LPE

2-Port SFP Ethernet Card with HSR/PRP Support

- 2 x SFP (100/ 1000 Mbps HSR/PRP selection by switch)
- Wide operating temperature range (-25~70 °C)
- Configuration tool for Windows and Linux
- Support IEEE 1588 PTPv2 standard

Industrial Ethernet Switches



EKI-5528I-MB	EKI-7720G-4FP1	EKI-5629C-EI	EKI-7712G-4FP1	EKI-7428G-4XP	EKI-9226G-20FOI
8FE Managed Ethernet Switch support Modbus/TCP	16GE PoE + 4G SFP Ports Managed Industrial PoE Switch	8FE+2G Combo Managed Ethernet Switch support EtherNet/IP	8GE PoE and 4G SFP Managed Ethernet Switch	24GE+4 10G SFP L2 Managed PoE Switch	IEC61850-3 20G SFP + 6GE Managed Ethernet Switch
<ul style="list-style-type: none"> • 8 x Fast Ethernet RJ-45 (EKI-5528/I-MB) ports • Entry-Level Managed Switch • IXM function enables fast deployment • Management: SNMP v1/v2c/v3, WEB, Standard MIB, Private MIB 	<ul style="list-style-type: none"> • 16 x IEEE 802.3af/at PoE ports • Up to 420W power budget • SFP socket for easy and flexible fiber expansion • Redundancy: X-Ring Pro (ultra-high-speed recovery time, <20 ms), RSTP/STP (802.1w/1D) • IXM function enables fast deployment 	<ul style="list-style-type: none"> • 8 x Fast Ethernet ports + 2 Gigabit Copper/SFP combo ports (EKI-5629C/I-EI) • Entry-level managed switch • IXM function enables fast deployment • Provides EtherNet/IP EDS (Electronic Data Sheet) file, AOI (Add-On Instructions) file, and FactoryTalk® View faceplate • Management: SNMP v1/v2c/v3, WEB, Standard MIB, Private MIB 	<ul style="list-style-type: none"> • 8 x IEEE 802.3 af/at PoE Gigabit ports + 4 SFP ports • SFP socket for Easy and Flexible Fiber Expansion • Redundancy: X-Ring Pro (ultra-high-speed recovery time < 20 ms), RSTP/STP (802.1w/1D) • IXM function enables fast deployment • Security: 802.1x (Port-Based, MD5/TLS/TTLS/PEAP Encryption), RADIUS 	<ul style="list-style-type: none"> • 24 x GbE ports and 4 x 10G SFP ports • 0 to 60°C operating temperature range • Management: SNMP v1/v2c/v3, WEB, Telnet, Standard MIB • IXM function enables fast deployment • Redundancy: Gigabit X-Ring Pro (ultra high-speed recovery time < 20 ms), RSTP/STP (802.1w/1D), MSTP 	<ul style="list-style-type: none"> • Dual Power input and 2 relay output • Redundancy: Gigabit X-Ring Pro (ultra high-speed recovery time < 20 ms), RSTP/STP (802.1w/1D), MSTP • Security: 802.1x (Port-Based, MD5/TLS/TTLS/PEAP Encryption), HTTPS, SSH and SNMPv3 • Management: SNMP v1/v2c/v3, WEB, Telnet, Standard MIB • SFP socket for Easy and Flexible Fiber Expansion

Unmanaged Ethernet Switches

Communication Gateways

Industrial Cellular Routers & Gateways



EKI-25251

EKI-2526M

IEC-1251

IEC-150

ICR-4461

Unmanaged Industrial Ethernet Switch

4FE+2FE SC Multi-mode Unmanaged Ethernet Switch

IEC-61850-3-Compliant Edge Communication Gateway with 2 x LAN, 4 x COM

NXP i.MX8M Quad Core Cortex A53, High-Performance IoT Gateway

Ultra High-Speed 5G Router & Powerful Edge Computing Gateway

- Provides 5/8 Fast Ethernet ports with Auto MDI/MDI-X
- Supports 10/100 Mbps Auto-Negotiation
- Provides compact size with DIN-rail/Wall mount, and IP30 metal mechanism
- Supports redundant 12 ~ 48 VDC power input and P-Fail relay
- Supports wide operating temperatures from -40 to 75°C

- Provides 4 x 10/100 Mbps Ethernet ports with RJ45 connector
- Provides 2 x 100 Mbps Multi-mode SC type fiber optic port
- Supports full/half duplex flow control
- Supports MDI/MDI-X auto crossover
- Provides Redundant 12 ~ 48 VDC power input

- ARM Cortex® A8 800-MHz processor w/ 256 MB of DDR3L RAM
- 2 x 10/ 100 MB LAN, 4 x RS-232/485 serial ports
- 1 x mini-PCIe slot for wireless expansion
- Wide operating temperature range (-40~70 °C)

- NXP i.MX8M Quad Core Cortex A53 1.3G CPU
- DDR4 2GB RAM, 16GB eMMC for system storage
- 2 x RS-232/485 isolated serial ports
- 2 x 10/100/1000 Ethernet ports
- 1 x Mini-PCIe for WIFI/Cellular/4G

- 5G NR Cellular Connectivity, Sub-6GHz
- 3GPP Release 16, Support both NSA and SA modes
- Quad-core CPU with 1 GB RAM
- 2 x SIM, eSIM Ready, TPM 2.0
- 5 x GbE (Optional 4x PoE+ PSE)
- 24 x GbE+ 4 x 10G SFP L2 Managed PoE Switch

Worldwide Presence

3 Manufacturing Sites

4 Logistics Centers

21 Service Centers

27 Countries

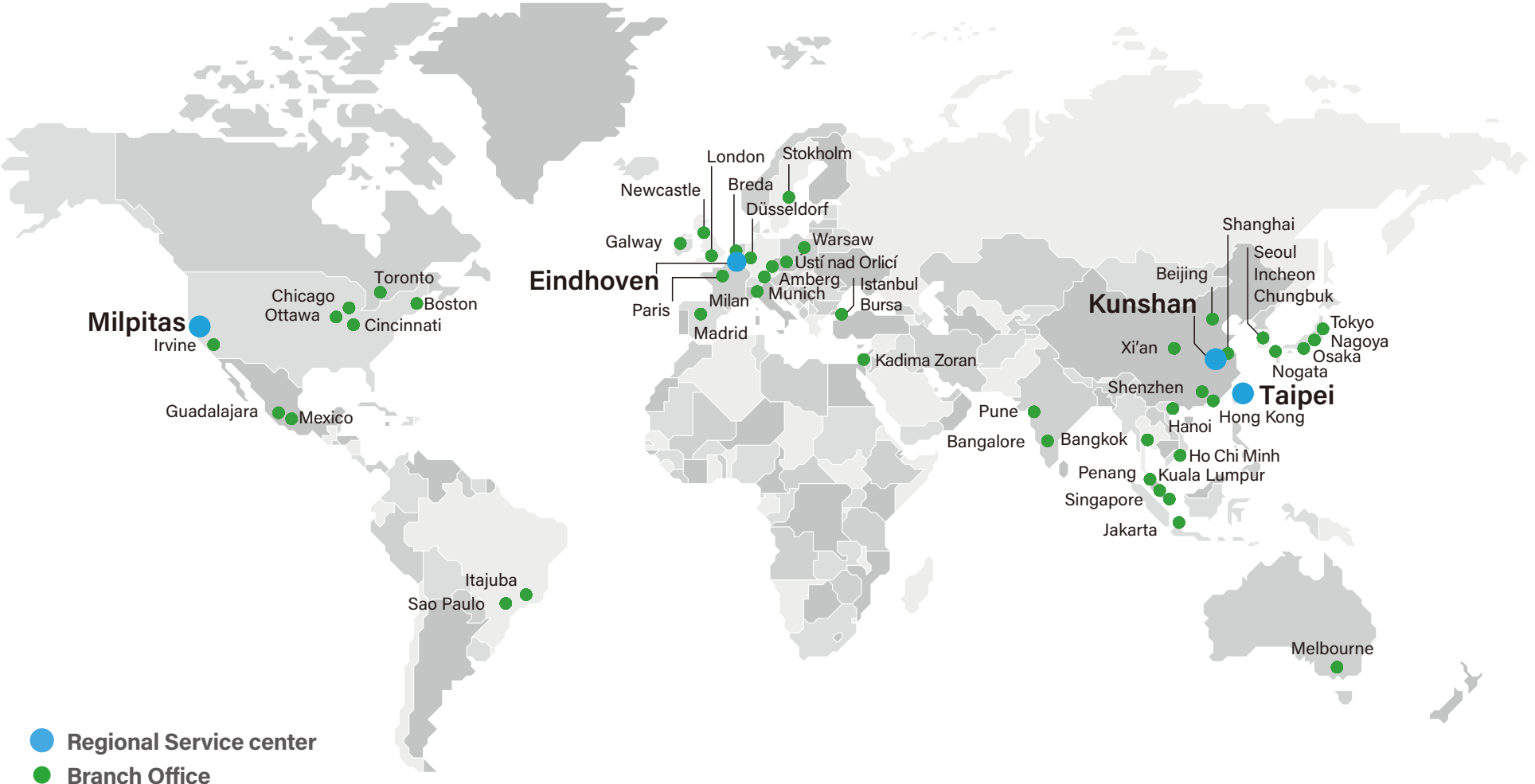

Regional Service and Customization Centers

China | Kunshan
86-512-5777-5666

Taiwan | Taipei
886-2-2792-7818

Netherlands | Eindhoven
31-40-267-7000

Poland | Warsaw
00800-2426-8080

USA | Milpitas, CA
1-408-519-3898

Worldwide Offices

Asia Pacific

Taiwan

Toll Free 0800-777-111
Taipei & IoT Campus 886-2-2792-7818
Taichung 886-4-2372-5058
Kaohsiung 886-7-392-3600

China

Toll Free 800-810-0345
Beijing 86-10-6298-4346
Shanghai 86-21-3632-1616
Shenzhen 86-755-8212-4222
Chengdu 86-28-8545-0198
Hong Kong 852-2720-5118

Japan

Toll Free 0800-500-1055
Tokyo 81-3-6802-1021
Osaka 81-6-6267-1887
Nagoya 81-0800-500-1055
Nogata 81-949-22-2890

Korea

Toll Free 080-363-9494/5
Seoul 82-2-3660-9255

Singapore

Singapore 65-6442-1000

Malaysia

Kuala Lumpur 60-3-7725-4188
Penang 60-4-537-9188

Thailand

Bangkok 66-02-2488306-9

Vietnam

Hanoi 84-24-3399-1155
Hochiminh 84-28-3836-5856

Indonesia

Jakarta 62-21-751-1939

Australia

Toll Free 1300-308-531
Melbourne 61-3-9797-0100

India

Bangalore 91-94-4839-7300
Pune 91-94-2260-2349

Americas

North America

Toll Free 1-888-576-9668
Cincinnati 1-513-742-8895
Milpitas 1-408-519-3898
Irvine 1-949-420-2500
Ottawa 1-815-433-5100
Chicago 1-888-576-9668

Brazil

Toll Free 0800-770-5355
São Paulo 55-11-5592-5367

Mexico

Toll Free 1-800-467-2415
Mexico City 52-55-6275-2777

Europe

Netherlands

Eindhoven 31-40-267-7000
Breda 31-76-523-3100

Germany

Toll Free 00800-2426-8080/81
Munich 49-89-12599-0
Düsseldorf 49-2103-97-855-0

France

Paris 33-1-4119-4666

Italy

Milan 39-02-9544-961

UK

Newcastle 44-0-191-262-4844
London 44-0-870-493-1433

Spain

Madrid 34-91-668-86-76

Sweden

Stockholm 46-0-864-60-500

Poland

Warsaw 48-22-31-51-100

Russia

Moscow 8-800-555-01-50
St. Petersburg 8-812-332-57-27
8-921-575-13-59

Czech Republic

Ústí nad Orlicí 420-465-524-421

Ireland

Galway 353-91-792444

Middle East and Africa

Israel 072-2410527
Turkey 90-212-222-0422
Turkey-Bursa 90-224-413-3134

ADVANTECH

Enabling an Intelligent Planet

www.advantech.com

Please verify specifications before ordering. This guide is intended for reference purposes only.

All product specifications are subject to change without notice.

No part of this publication may be reproduced in any form or by any means, electronic, photocopying, recording or otherwise, without the prior written permission of the publisher, without prior written permission of the publisher.

All brand and product names are trademarks or registered trademarks of their respective companies.

© Advantech Co., Ltd. 2023



8600000628